

Figure 5.1 Tile Dimensions

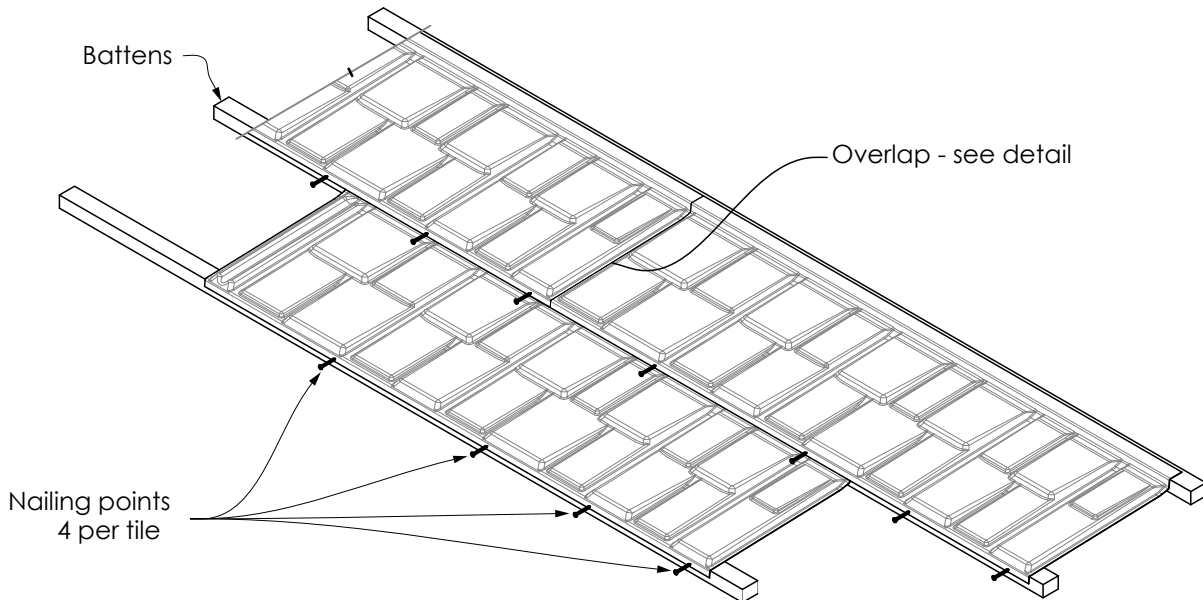

Figure 5.2 Nailing Detail

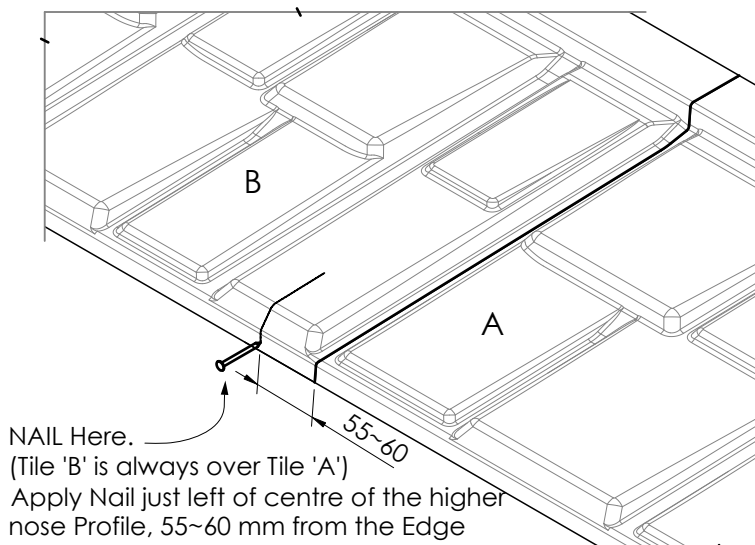

Figure 5.3 Overlap Detail

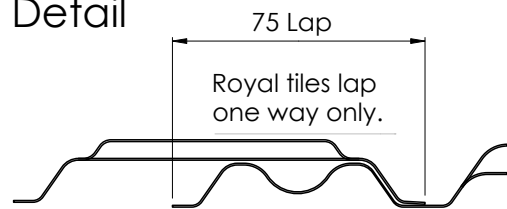

Figure 5.4 Lap Section

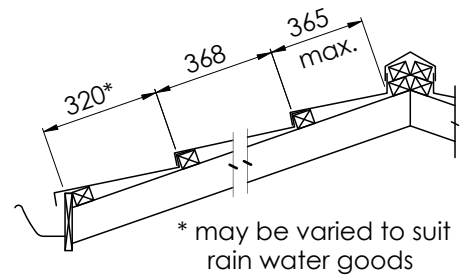

Figure 5.5 Batten Layout