

Figure 1.1 Tile Dimensions

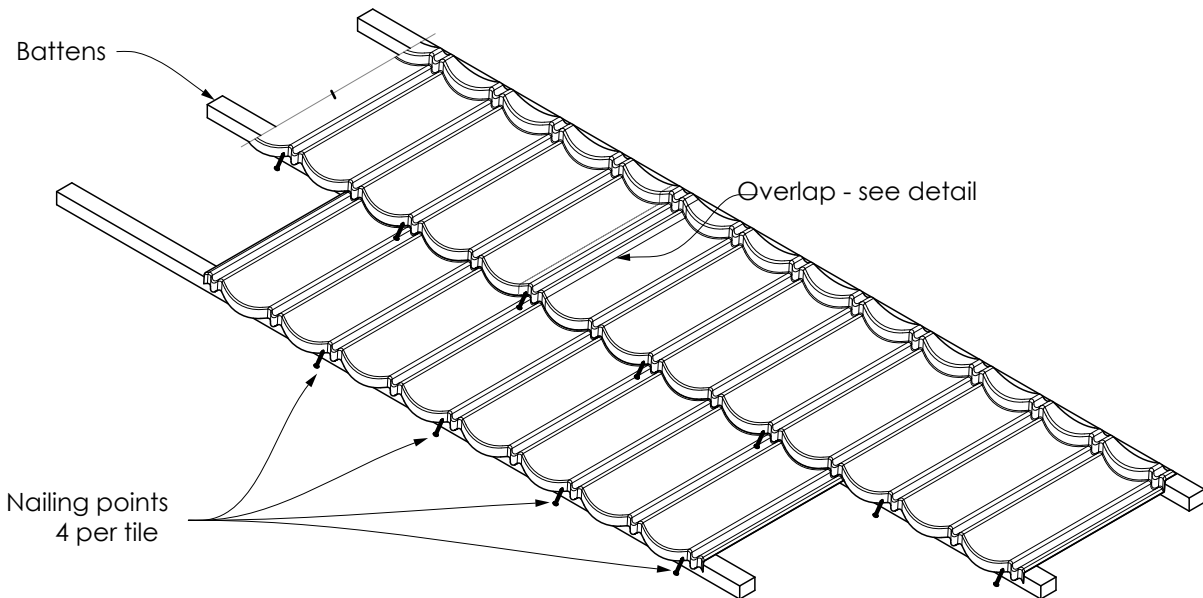

Figure 1.2 Nailing Detail

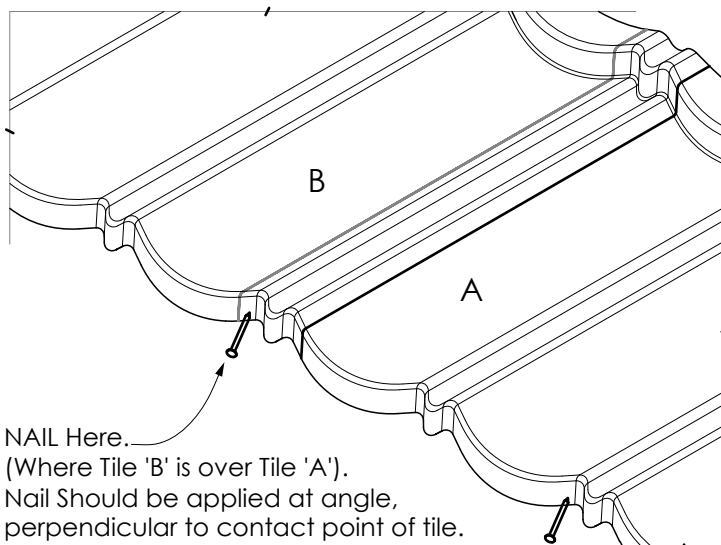

Figure 1.3 Overlap Detail

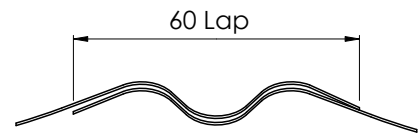

Figure 1.4 Lap Section

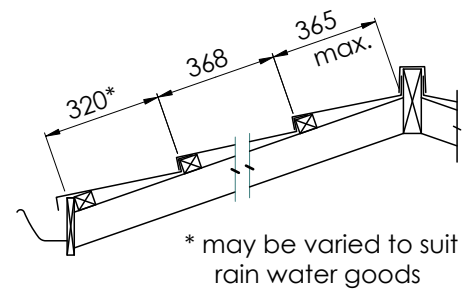

Figure 1.5 Batten Layout